



Kugelkupplungssystem 80mm für Fahrzeugtransporter

- Einfach austauschbar (Normlochbild G 6), absperrrbar
- Innovatives Verschlusssystem sorgt für einfache und sichere Bedienung
- Spielfreiheit gewährleistet optimalen Fahrkomfort
- Integrierter Dichtring sorgt für lange Lebensdauer und geringeren Verschleiß
- Geringere Abnutzung von Zugöse und Kugel durch zusätzlich eingebaute Schmieraschen



RO★KU 80

Technische Daten



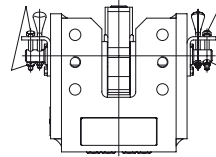
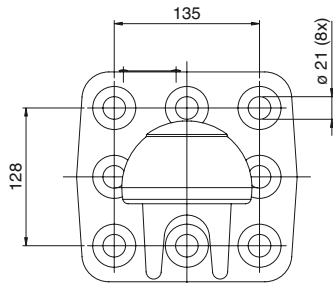
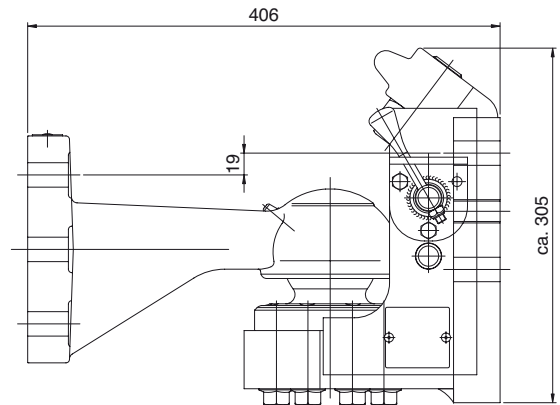
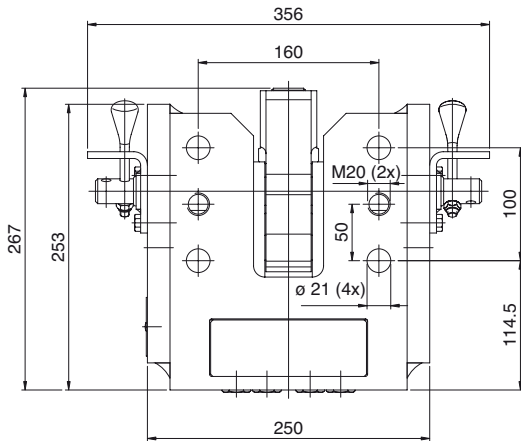

Kugelpkupplungssystem 80 mm

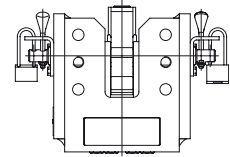



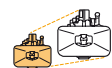

Bei Verwendung nach ECE55/Klasse T müssen beide Sicherungsbolzen mit je einer Schraube B, gesichert werden.

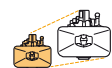

Bei Verwendung nach EG94/20 werden beide Sicherungsbolzen mit je einem Bügelschloß gegen unbefugtes Öffnen gesichert.

 	 (mm)	 D (kN) Dc (kN)		 S (kg) V (kN)		 komplett mit Zugöse (kg)	e11	E11	
R0908H61000	6	160x100	140,0	140,0	1000	90	65,4	00-5779	–
R0908H61000	6	160x100	140,0	140,0	2500	75	65,4	00-5779	–
R0908H61000	6	160x100	–	140,0	1000	90	65,4	–	015779
R0908H61000	6	160x100	–	140,0	2500	75	65,4	–	015779

Schraubensatz 85 mm

 	 (mm)	 D (kN) Dc (kN)		 S (kg) V (kN)		 komplett mit Zugöse (kg)	e11	E11	
R0908H61500	6	160x100	140,0	140,0	1000	90	65,4	00-5779	–
R0908H61500	6	160x100	140,0	140,0	2500	75	65,4	00-5779	–
R0908H61500	6	160x100	–	140,0	1000	90	65,4	–	015779
R0908H61500	6	160x100	–	140,0	2500	75	65,4	–	015779

Schraubensatz 110 mm