

RO★244 L



ROCKINGER



Neu: auch mit zwei Pedalen erhältlich

Flurförder-Anhängekupplung mit Sicherungsanzeige und ECE-Zulassung

- Ergonomisch: Ausführung mit Fußbetätigung
- Neu: auch mit zwei Pedalen erhältlich
- Flexibel: Bedienung von beiden Seiten möglich
- Sicher: eindeutige Sicherungsanzeige
- ECE-geprüft und zugelassen
- millionenfach bewährt

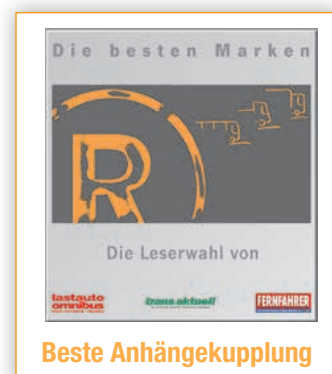

RO★244 L

Technische Daten

Kompaktkupplung für Flurförderzeuge
und deren Anhänger

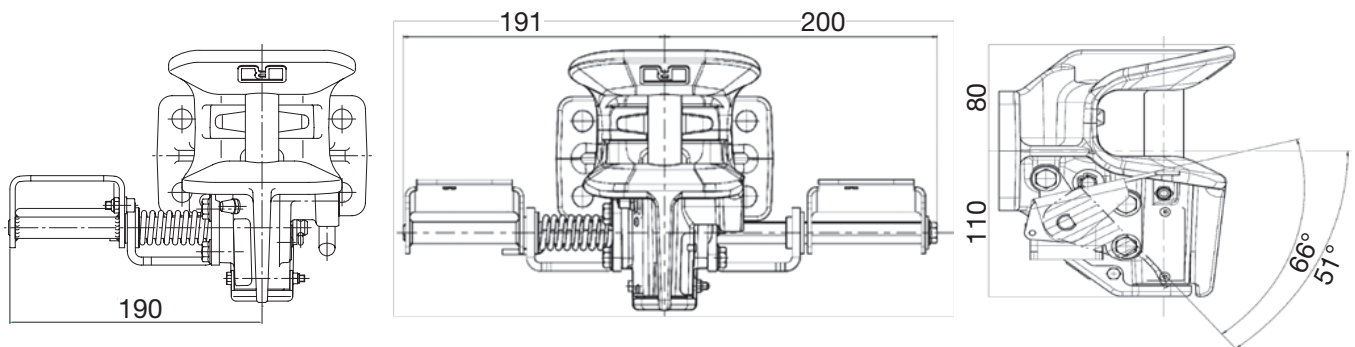









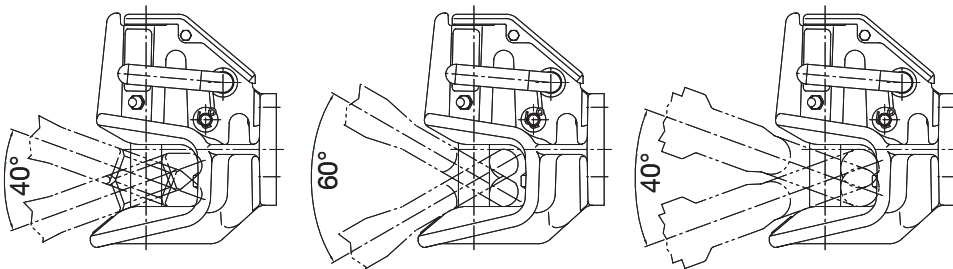

Für Zugöse:

1) DIN 74054

2) DIN 8454

3) CUNA 438/40



	Klasse Class	 (mm)	 D (kN)	 D (kN)	 V (kN)	 S (kg)	 (kg)				ECE
R0244L35002	S	120x55	42	30/18	8,4/12	250	7	X	X	-	E1 55R-01 1802
R0244L35502	S	120x55	42	30/18	8,4/12	250	8,2	-	-	X	E1 55R-01 1802
R0244L11002	S	83x56	42	42	12	250	7	X	X	-	E1 55R-01 1804
R0244L07002	S	130x30	42	42	18	250	7	X	X	-	E1 55R-01 1803

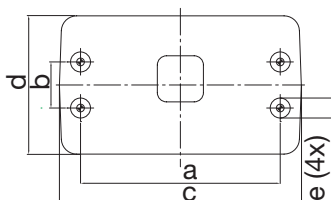

	a (mm)	b (mm)	c (mm)	d (mm)	e (mm)
07	130,0	30,0	158,0	90,0	13,0
115	83,0	56,0	158,0	90,0	10,5
135	120,0	55,0	158,0	90,0	15,0